



INSTALLATION INSTRUCTIONS

Accessory
FRONT SPLASH GUARD
P/N 08P08-SWA-100

Application
2010 CR-V

Publications No.
All 42603
Issue Date
AUG 2009

NOTE: Front splash guards cannot be installed if vehicle is equipped with running boards.

PARTS LIST

Left front splash guard

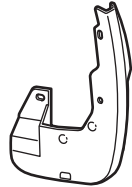

Right front splash guard

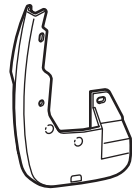

TOOLS AND SUPPLIES REQUIRED

Stubby Phillips screwdriver

INSTALLATION

NOTE:

- These instructions show the left splash guard being installed. The same procedure applies to installing the right splash guard.
- Clean and wax the areas to be covered with a high-quality paste wax.

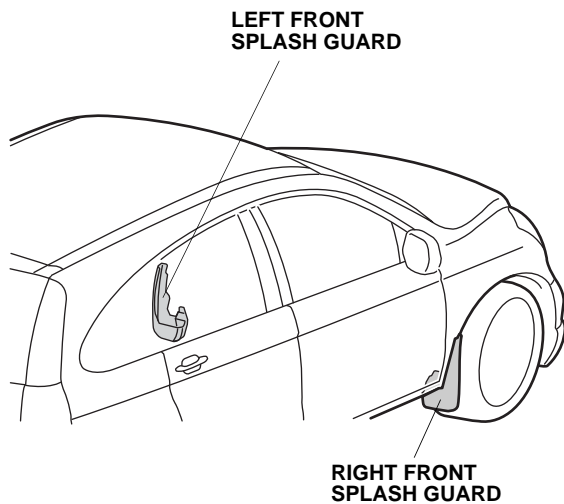

1. Turn the steering wheel all the way counterclockwise.
2. Remove and retain the three self-tapping screws fastening the left front inner fender to the front fender and fenderwell.

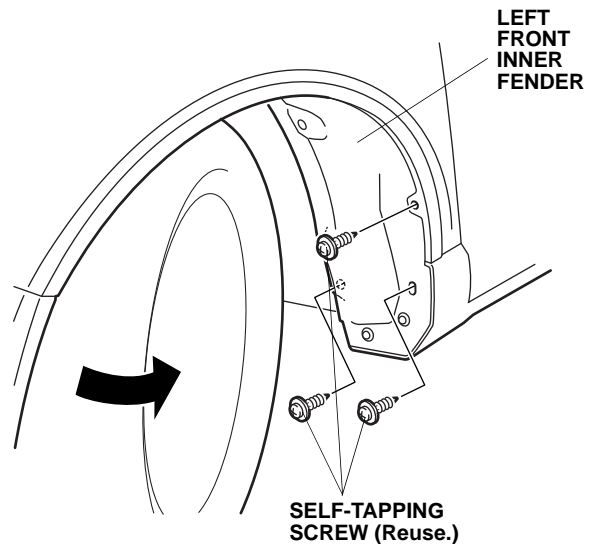

3. Position the left front splash guard on the left front inner fender, and install the three self-tapping screws you removed in step 2.
4. Turn the steering wheel all the way clockwise, and repeat steps 2 and 3 to install the right splash guard.

